14-5-2018



WESSELING BV

Quality since 1958

MONDIAL 6

USER'S MANUAL AND MAINTENANCE GUIDE



CE

1. GENERAL INFORMATION	2
MANUFACTURER	2
EQUIPMENT INTENDED USE AND DESCRIPTION	2
STORAGE	2
SYMBOLS	2
2. SPECIAL WARNINGS AND USE RESTRICTIONS	3
3. USE	3
STARTING UP	3
SETTING UP AND ADJUSTMENTS	3
TRANSPORTATION AND BRAKES	4
4. CLEANING and CONSERVATION	5
5. MAINTENANCE	5
SPARE PARTS:	5
6. TROUBLESHOOTING	6
7. TECHNICAL DATA SHEET	7
8. WARRANTY	8
9. SERVICE RECORD	8

1. GENERAL INFORMATION

MANUFACTURER

Wesseling BV, Venenweg 31, 1161 AK Zwanenburg, Netherlands-Tel.+31 204975183-Fax+31 204975909 – website:www.wesseling-bv.com

EQUIPMENT INTENDED USE AND DESCRIPTION

The Mondial tables are intended for examining and treating patients. With the additional options this table can be used for treatment and examination. The entire frame is epoxy powder coated and the top is upholstered and covered in fireproof synthetic leather. It's equipped with a high quality actuator for height adjustment. Head- and back section as well as sitting- and leg section can be inclined with the help of gas springs. The gas springs are all adjusted by handles that are easy to access on the side of the table. The brakes and lock are centrally controlled by means of a foot pedal that is easy to activate.



STORAGE

When storing, the following conditions must be met:



1. Relative humidity 10% / 90 % - temperature -10°C / +50°C

SYMBOLS

The various symbols appearing in this manual and on the equipment itself are meant to draw the user's attention on important safety warnings and useful information. Please observe all warning, caution and hazard notices.

	WARNING Warning messages are used to advise users/patients about any risk of injury or danger if the specified procedures and conditions are not carefully observed during operation or maintenance activities.
	CAUTION Caution symbols are used to advise users about an operation or maintenance procedure, best practice or condition that may damage the equipment if not duly complied with.

2. SPECIAL WARNINGS AND USE RESTRICTIONS

	<p>Equipment must not be used:</p> <ul style="list-style-type: none"> • Without knowing the user's manual. • When the safety load exceeds the stated capacity. • Without the patient being monitored. • When the patient and/or equipment is not stable enough. • When table is not on its feet when stopped, during treatment, or when patient is moved to/from other equipment. • When the original product has been tampered with and/or modified from its original configuration. • When the controls and/or components are even only partially faulty or defective. • When incorrectly configured or when you think it may cause damage to a patient or user. • Do not allow any body parts to enter the areas with moving components and/or controls.
	<ul style="list-style-type: none"> • Foam rubber and plastic components may burn if they come in contact with naked flames. • Corrosive and/or abrasive detergents may damage the covers and paintwork. • The equipment is not suitable for use outdoors and/or in surfaces that are not smooth enough.
<p>!!!!!!!!!!!! NEVER LEAVE THE TABLE UNATTENDED WHEN THERE IS A PATIENT ON IT !!!!!!!!!!!!!</p>	









3. USE









STARTING UP

For packaging reasons the couch is supplied covered by protective means that are to be removed, avoiding direct contact with cutters that could damage it. Any damage in transit must be reported to the transporter and seller immediately, without using the equipment for safety reasons.

SETTING UP AND ADJUSTMENTS

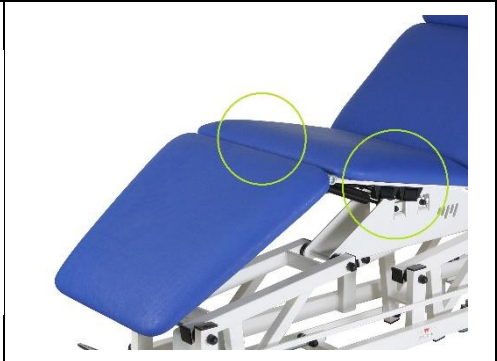
The table has an electric actuator for the height adjustment. The head section and the back section are both fitted with gas springs.

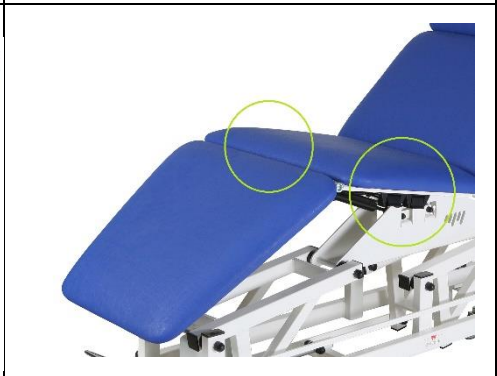
ADJUSTMENT/FUNCTION	CONTROL	PROCEDURE
		Table is standard equipped with a 24v foot switch or hand switch.
		Push the relevant symbol to adjust the height of the entire table.
		<p>To adjust the head section pull the control handle, and support the section as it moves. Release the handle to secure the position. The control handles are on both sides of the table.</p> <div style="border: 1px solid black; padding: 5px; text-align: center;"> <p> WARNING </p> <ul style="list-style-type: none"> • With the patient's weight on the section, activate the control handle only when you are sure that the entire load is supported. • Movement of the adjustable sections may cause pinching in the vicinity of the hinges. </div>

		<p>To adjust the head section pull the control handle, and support the section as it moves. Release the handle to secure the position. The control handles are on both sides of the table.</p> <p style="text-align: center;">WARNING</p> <ul style="list-style-type: none"> • With the patient's weight on the section, activate the control handle only when you are sure that the entire load is supported • Movement of the adjustable sections may cause pinching in the vicinity of the hinges • Do not sit on the head section
		<p>To adjust the back section pull the control handle, and support the section as it moves. Release the handle to secure the position. The control handles are on both sides of the table.</p> <p style="text-align: center;">WARNING</p> <ul style="list-style-type: none"> • With the patient's weight on the section, activate the control handle only when you are sure that the entire load is supported. • Movement of the adjustable sections may cause pinching in the vicinity of the hinges.
		<p>To adjust the sitting section pull the control handle, and support the section as it moves. Release the handle to secure the position. The control handles are on both sides of the table.</p> <p style="text-align: center;">WARNING</p> <ul style="list-style-type: none"> • With the patient's weight on the section, activate the control handle only when you are sure that the entire load is supported. • Movement of the adjustable sections may cause pinching in the vicinity of the hinges.
		<p>To adjust the leg section pull the control handle, and support the section as it moves. Release the handle to secure the position. The control handles are on both sides of the table.</p> <p style="text-align: center;">WARNING</p> <ul style="list-style-type: none"> • With the patient's weight on the section, activate the control handle only when you are sure that the entire load is supported. • Movement of the adjustable sections may cause pinching in the vicinity of the hinges. • Do not sit on the leg section
		<p>To adjust the armrests loosen the lever of the armrest you want to adjust. Move the armrest in the desired direction and fasten the lever to keep it in place.</p> <p style="text-align: center;">WARNING</p> <ul style="list-style-type: none"> • With the patient's weight on the section, loosen the lever only when you are sure that the entire load is supported. • Movement of the adjustable sections may cause pinching in the vicinity of the hinges. • Do not sit on the armrests

 **WARNING** 



- Do not exceed the weight limit of 75kg on both ends of the table. This could cause damage to the gas springs fitted underneath.



TRANSPORTATION AND BRAKES

The table has four swivel wheels to allow movements in tight spaces. At the back-side of the table is the stirrup bar of the wheel-lift system. By pushing this stirrup bar downwards the table becomes mobile. Lift the stirrup bar upwards again after reaching the required position so the castors will be retracted. Never use the table if the castors are not fully retracted! The 4 feet can be adjusted individually when the floor is not even.

MOVING THE TABLE	PUT THE TABLE ON ITS FEET	PROCEDURE
		<ul style="list-style-type: none"> To move the table use the foot to push down the bar till it stops. To put the table on its feet use the foot to push up the bar until all the feet are on the floor.

 **WARNING** 

- Putting the table on its feet is essential when transferring and treating the patient.

4. CLEANING and CONSERVATION

For durable joy with the leather material, please clean regularly. For cleaning use a cloth or soft brush dampened using water and a neutral detergent. Any stains on the upholstery should be promptly removed with colourless ethyl alcohol diluted in 20% water. Rinse well.

WARNING

- ENSURE THE COUCH IS PERFECTLY CLEAN BY DISINFECTING THE SYNTHETIC LEATHER AND APPLYING A SINGLE-USE PAPER SHEET AT EVERY USE.
- HARSH DETERGENT PRODUCTS MAY DAMAGE THE SURFACES.
- DO NOT USE STEAM JETS, WASHING TUNNELS, WATER JET CLEANERS OR HIGH PRESSURE WASHERS

5. MAINTENANCE

Maintenance operations must be carried out by technicians who are familiar with the contents of this instruction booklet. Check the equipment is safe after any instances of "rough handling" (e.g. fall, bumps, etc.) and any time you are in doubt about safety.

ROUTINE MAINTENANCE

Routine maintenance operations must be carried out with the frequency indicated in the table.

FREQUENCY	ACTIVITY
Every 6 months or at least once a year	General equipment cleaning.
	Visual and functional inspection of the equipment and related hydraulic and manual controls.
	Frame and mechanical parts: Check screws and bolts are tight; state of wear of bushings and pins, presence of tears and deformations or damages.
	Oil leaks from the piston and/or gas springs must only be in the form of minor lubrication residue.
	Check that the adjustable sections are stable and do not give way when the control lever is released.
	Brake control: check regular functioning of the activating device and the efficiency of the brakes.
	Wheels: these must be securely fixed and in good condition, rolling smoothly and with their treads free of impediments.
During use and operation, make sure there are no unusual sounds, vibrations or oscillations that may indicate actuator and/or mechanism malfunctions.	
At the end of the activities above, complete the inspection performing a lift cycle with the stated maximum safe load.	

NON-ROUTINE MAINTENANCE

For safety reasons and to avoid invalidating the guarantee, no component may be opened or handled for repair. Any faults on the hydraulic piston, the gas springs and the wheel system must be diagnosed by Wesseling BV, who will organize the most suitable action.

WARNING

- IF SAFETY SEEMS TO BE AT RISK, DISABLE THE EQUIPMENT IMMEDIATELY PREVENTING ANY POSSIBILITY OF USE UNTIL SUCH RISK HAS BEEN REMOVED.
- PLEASE RECORD ANY DEFECTS/DAMAGES/SERVICES THAT ARE IMPORTANT FOR THE SAFETY OF THE EQUIPMENT IN THE APPROPRIATE FORM HEREWITH ENCLOSED.

SPARE PARTS

Only use original spare parts from Wesseling. Please contact Wesseling BV for the parts you might need.

6. TROUBLESHOOTING

DIRECT E-MAIL FOR TECHNICAL OR USERS ASSISTANCE:

info@wesseling-bv.com

If you rather want to speak to one of us on the phone you can call: +31-20 497 5183

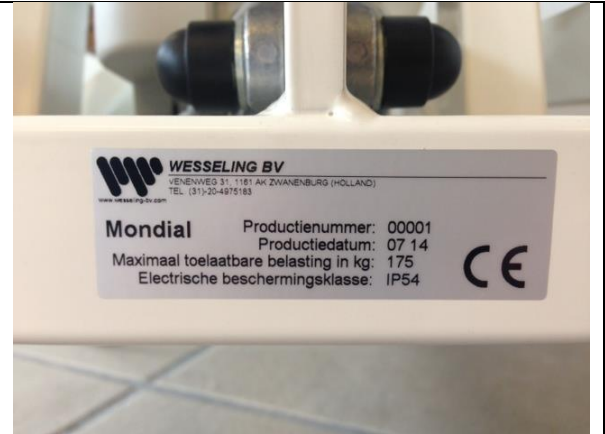

Please note:

- Before contacting for service or help, please identify the "SERIAL NUMBER" in the product label attached to the equipment (see example above), or the transport document/invoice number. This will speed things up and improve service quality.

The equipment was tested in very stringent conditions. During testing no specific breakages or faults occurred. If the equipment fails to operate, please follow the troubleshooting process below.

Issue	Cause	Solution
Adjustment of the head-/sitting section doesn't work or the position is not maintained	Gas spring faulty or incorrectly set	Contact Wesseling BV
	Transmission cable damaged or broken	
The actuator does not work	The attached switch is broken or not connected properly	Contact Wesseling BV
	Power cable is damaged or not connected properly	
	Actuator is damaged or not connected properly	

7. TECHNICAL DATA SHEET

Product Name	Mondial 6 Hydraulic without / with castors	Mondial 6 Electric without / with castors
Product code	MON6HMW / MON6HZW	MON6EMW / MON6EZW
Veilige werkbelasting	200kg	200kg
Max patiënten gewicht	175kg	175kg
Hoogte verstelling	46 to 98 cm, hydraulic pump, 10.000N, stroke 200mm	46 to 98 cm with a speed of 7,5mm/s - 8.000N, 470W, 2.0Ah, stroke 200mm
Adjustment system	Dutch hydraulic pump	German electric actuators
Adjusting	Footpedals on both sides of the table	24v foot- or hand switch
Sections adjusted by gas spring	4	4
Head section	-90° tot +15°	-90° tot +15°
Back section	-20° tot +75°	-20° tot +75°
Sitting section	-20° tot +75°	-20° tot +75°
Leg section	-25° tot +75°	-25° tot +75°
Adjusting gas springs	By levers that are on both sides of the table	By levers that are on both sides of the table
Armrests	0 – 15cm	0 – 15cm
Wheels	Ø75mm	Ø75mm
Braking system	Centralized control on the back of the table	Centralized control on the back of the table
Gewicht product	± 85kg	± 85kg
Length	200cm	200cm
Width	64cm or 70cm (optional)	64cm or 70cm (optional)
Dikte polstering	± 55mm	± 55mm
Filling	Polyether SG 90/30	Polyether SG 90/30
Semi Leather	Standard artificial leather, Original SKAI® or STAMSKIN	Standard artificial leather, Original SKAI® or STAMSKIN

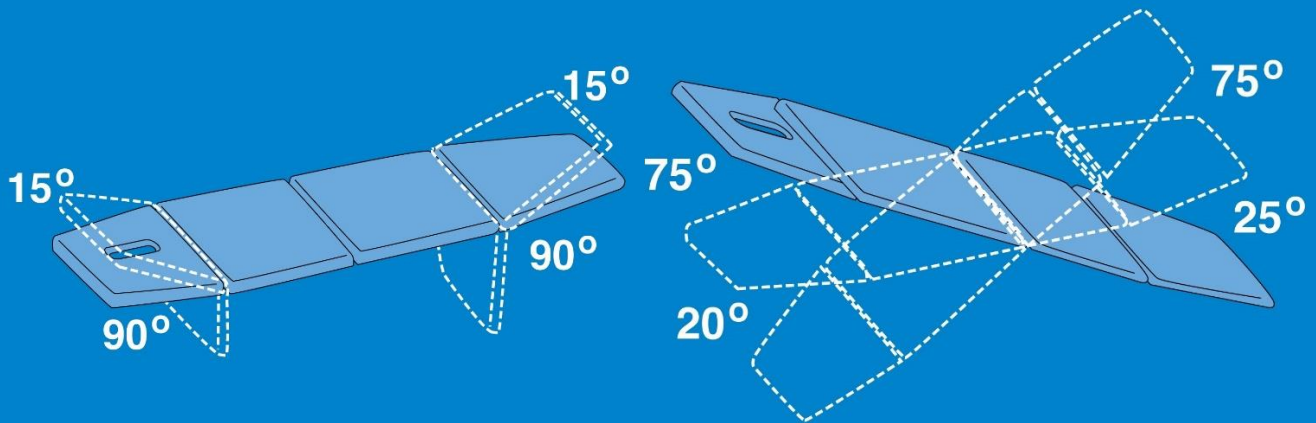

8. WARRANT

GENERAL AFTER-SALES SERVICE CONDITIONS FOR WESSELING ITEMS

The warranty has a 24-month validity from the date of delivery.
 The warranty does not cover consumable items, rechargeable batteries, and generally all the material subject to wear, breakdowns caused by knocks, falls, misuse or improper use, accidental events and transport damage. This warranty shall be automatically invalidated if the equipment is tampered with.
 Repair of the equipment will be carried out in relation to the breakdown stated.
 An estimate must be specifically requested.
 Payment is cash on delivery, unless other agreements are made.
 For any dispute, the sole competent court shall be the court of Amsterdam

WARRANTY REPAIRS

Warranty repairs must be expressly requested.
 Repairs under warranty shall be carried out at our workshop and upon authorization
 The return shipment for products sent in their original package will be made free of carriage charges.
 A fiscal document (bill of sale, purchase invoice or cash receipt) is required to make a warranty claim; the purchase date indicated must fall within the warranty time period.
 If, upon inspection, the product appears to be fully functioning, troubleshooting expenses shall still be charged to the client.

OUT OF WARRANTY REPAIRS

For out-of-warranty repairs carried out at our workshops upon authorization, transportation charges shall be paid by the customer.
 The warranty of the parts replaced during the repair operations is 12 months from the moment the equipment is collected.
 If, upon inspection, the product appears to be fully functioning, troubleshooting expenses shall still be charged to the client.

REPAIRS MADE AT HOME

In the event repairs are made at the customer’s home, a written request is required indicating the complete details of the person making the request, the type of machine and the breakdown.
 The cost per kilometer for on-site technician visits will be agreed upon in relation to the urgency of the customer.
 In the event the machine is under warranty, the customer will have to pay only the expenses incurred for the technician to reach the customer’s house.
 Time is calculated from the moment the technician leaves our workshop until he/she returns. The time of his/her return will be estimated based on the time required to get there.

SALE OF SPARE PARTS AND CONSUMABLE ITEMS

The orders must be in writing and specify the customer, the item and the shipping method as well as the precise fiscal data of the customer.
 The order processing time can vary depending on the availability of the material.
 Returned spare parts will not be accepted.
 Payment will be cash on delivery, unless other agreements are made.

9. SERVICE RECORD

EQUIPMENT:		DATE OF FIRST INSTALLATION:		SERIAL NUMBER:	
DATE OF SERVICE	OPERATIONS CARRIED OUT	TECHNICIAN	SIGNATURE	NEXT DUE DATE	